



IFU VERSION: 3.2
DATE: 27.12.2023

Copyright © Norav,

No part of this publication may be reproduced in any material form (including photocopying or storing it in any medium by electronic means whether or not transiently or incidentally to some other use of this publication) without the prior written permission of the copyright owner, or under the terms of a license issued by the copyright owner.

The information contained in this document is subject to change without notice. Norav is neither responsible for nor liable to anyone in connection with this document.



Manufactured by:

Norav Medical GmbH
Christof Ruthof Weg 10
55252 Mainz Kastel
Germany
Tel: [\(+49\) 6134-5679830](tel:+4961345679830)
Mail: info@norav.com

United Kingdom [UK Representative]:

Physiological Measurements Ltd.
The Old Malt House
Willow Street
Shropshire, SY11 1AJ
United Kingdom
Tel: (+44) 1691 676496
Mail: info@pml.tel



Caution

Federal Law restricts this device to sale by or on the order of a licensed physician or healthcare provider.

Disclaimer

This system is intended as a decision support system for persons who have received appropriate medical training and should not be used as a sole basis for making clinical decisions pertaining to patient diagnosis, care, or management. Any application of medical information from the program, other than the original design or intended use thereof, is not advised and considered a misuse of the software product.

Norav Limited Warranty

Norav products are warranted to be free from manufacturing and material defects for a period of one (1) year from the date of shipment from Norav or the dealer to the original purchaser.

Excluded from this warranty are expendable supply items including, but not limited to, electrodes, lead wires, patient cables, and batteries. This warranty does not apply to any product that Norav determines that it has been modified or damaged by the customer.

Except for the express warranties stated above, Norav disclaims all warranties including implied warranties of merchantability and fitness. The stated express warranties are in lieu of all obligations or liabilities on the part of Norav for damages, including but not limited to, special, indirect, or consequential, arising out of or in connection with the use or performance of Norav products.

Any action for breach of warranty shall be commenced within one (1) year of said breach or be forever barred. Any repairs made to the product that are not covered by the warranty shall be billed to the customer.

For service or technical support contact your local supplier or Norav Medical.

Contents

Disclaimer	2
Norav Limited Warranty	2
Symbols and Notations Used in this Manual.....	4
Device Label Symbols.....	4
General Description.....	5
NR Feature Matrix.....	5
Intended Use.....	5
Indications for Use	6
Contraindications and Potential Adverse Effects	6
Warnings and Precautions	7
Device Controls and Indicators	9
Memory Card Usage (SD card).....	12
Main Battery.....	13
RTC Back up Battery	13
Electrode Application Guide	14
Electrode Placement Scheme.....	15
Patient Cable Connection	16
Screen Navigation	17
Common Modes and Workflows.....	20
ECG Recording Procedure: Detailed Instructions	21
Maintenance and Cleaning	23
Cleaning and Disinfection for devices and patient lead wires * Before the Cleaning and Disinfection process, remove the battery.	23
Storage.....	25
Service.....	25
Calibration.....	25
Troubleshooting.....	26
Technical Specifications.....	27
ECG Cables and Accessories	29
Electromagnetic Emissions and Immunity Information	30
FCC Information	33

Symbols and Notations Used in this Manual



Warnings call attention to possible hazards involving potential damage or injury to persons.

WARNING



Cautions refer to practices necessary to protect against potential damage or loss to equipment. Pay careful attention to instructions.











Caution











Notes provide pertinent information to help obtain optimum performance from the software or signify an important step or procedure that requires special attention.

Note

Device Label Symbols

Symbol	Description
	Applied part type BF
	Defibrillator-proof type CF applied part
	Defibrillation protection in patient cable
	Caution
	Refer to operation manual NOTE On ME EQUIPMENT "Follow instructions for use"
	IP protection class
	Device Serial Number
	Device Reference Number
	Manufacturer
	Date of manufacture
	Use AA (R6) batteries.

	Contains FCC certified Bluetooth module
	Disposal of the device in accordance with the EU Directive 2002/96/EC (WEEE). Device containing an internal lithium battery that may be recycled at end of life. This device and all other accessories should be disposed of according to local ordinances.
	Indicates the proper orientation of battery to be installed
	By prescription only. U.S. Federal Law restricts this device to sale on order of a physician only.
	Contains MIC certified Bluetooth module
	Contains RCM certified Bluetooth module
	Unique Device Identification (UDI) information
	Medical device
	Model Number

General Description

The NR series (here and later “NR”) is a digital device which allows acquisition of ECG waveforms with further recording and/or transmitting the data to the external computer system.

NR Feature Matrix

The following table shows the available features depending on the device model.

Model	ECG channels	Patient cable Leads	Pacemaker detection	Acceleration sensor	Respiration signal	Voice recording	Bluetooth communication	USB communication	Ambulatory (Holter recording)	Resting ECG	Stress ECG	Telemetry ECG	Ambulatory Event recording
NR-302	3	3, 5, 7	yes	no	no	no	no	yes	yes	no	no	no	no
NR-314	3	3, 5, 7	yes	yes	yes	yes	yes	yes	yes	no	no	no	yes
NR-314-T	6	4, 5	yes	no	no	no	yes	no	no	no	no	yes	no
NR-1207	3, 12	3, 5, 7, 10	yes	yes	yes	yes	yes	yes	yes	no	no	no	yes
NR-1207-3	3, 6, 12	3, 4, 5, 7, 10	yes	yes	yes	yes	yes	yes	yes	yes	yes	yes	yes
NR-1207-E	6, 12	4, 5, 10	yes	no	no	no	yes	no	no	yes	yes	no	no
NR-314P	3	3, 4, 5	yes	yes	no	no	yes	yes	yes	no	no	yes	yes

Intended Use

Intended for patients requiring:

- Ambulatory Holter ECG
- Ambulatory Event ECG
- Use within the physician office setting by the medical professional
 - Resting ECG
 - Stress ECG

- Telemetry ECG

Indications for Use

The NR device is indicated for use on patients who may be asymptomatic or who may suffer from transient symptoms such as palpitations, shortness of breath dizziness, light headedness, pre-syncope, syncope, fatigue, chest pain, anxiety, suggesting arrhythmia or myocardial ischemia; for evaluation of ECG documenting therapeutic interventions in individual patients or groups of patients; for evaluation of patients for ST segment changes; for evaluation of a patient's response after resuming occupational or recreational activities (for example, after myocardial infarction or cardiac surgery); for clinical and epidemiological research studies; for evaluation of patients with pacemakers; for reporting of QT interval; etc. The NR device has been designed for use by medical clinical professionals. The medical clinical professionals must instruct the patient in the correct use, and it is important the patient can understand the instructions given by medical clinical professionals.

Contraindications and Potential Adverse Effects

There are no known contraindications or adverse effects for using NR equipment.

Warnings and Precautions



WARNING

- Models NR-314-T, NR-1207-E and NR-1207-3 are protected against the defibrillator when a defibrillation protected patient cable is used.
- To avoid the possibility of injury/hazardous situations during cardiac defibrillator use, a protected against the defibrillator cables must be used.
- To avoid the possibility of injury during patient defibrillation, do not come into contact with device or patient cables. Additionally, proper placement of defibrillator paddles in relation to the electrodes is required to minimize harm to the patient.
- Models NR-314, NR-302, NR-1207 and NR-314P are NOT protected against the defibrillator. When using the defibrillator, remove NR device from the patients.
- The NR device is not intended for use on infants weighing less than 10 kilograms (22 pounds).
- The NR device is not protected against the high-frequency surgical apparatus. When using the high-frequency surgical apparatus, remove NR device from the patient.
- NR device is not directly applicable to the heart.
- Do not use the NR device in an area where using combustible or flammable gas or liquid such as anesthetic, oxygen, or hydrogen.
- The power supply of NR device and patient circuit are not distinctly isolated. Only use batteries that are specified for the operation. Do not, under any circumstances, use a non-battery external power supply- this could threaten the patient's life.
- Any attempt to use NR device in an area where MRI is operating will mutually generate negative effects.
- Make sure that the electrode plug (patient side) never comes into contact with live parts. Do not operate the NR device near exposed live parts.
- Store the NR device safely away from children.
- Before each recording and before attaching sensors or electrodes to the patient, check the casing and the ECG patient cable for damage which may have occurred, for example, due to mechanical overload, falling from a great height or wear and tear (chafed patches on the cable). Do not use the instrument or the cable if you detect cracks, melted areas or any other signs of damage to the cable or housing.
- Do not connect NR device other than the specified equipment for your safety and optimal performance.
- Avoid touching the snap terminals and leadwires of NR device to other conductive parts or earth, as this may damage the NR device



Caution

- Store the NR device in an area free from water or humidity
- Take care to avoid areas subject to high humidity, poor ventilation and direct sunlight; store the NR device in an area free from any adverse effects of surrounding air containing dust, sodium, and sulfur.
- Do not store the NR device in an area where chemicals are kept, or which is exposed to chemical fumes or vapors.
- Never attempt to modify or to disassemble the NR device.
- Do not open the case except for by our service person.
- Check that electrodes are correctly and completely installed.
- When using NR device in combination with any other equipment, refer to a qualified service technician for correct handling.

**Caution**

- When changing the batteries (all but NR-314P models), make sure you insert them correctly (polarity). The polarity is indicated in the battery compartment.
- Do not leave the batteries in the NR device (all but NR-314P models) when it is not in use. Damage to the NR device could result from corrosion of the batteries.
- Even though that the NR device is protected against ingress of liquids, during a recording prevent it from being exposed to liquids. The NR device is not suitable for use in the bath tub or shower.
- During recording, make sure that the cable lead wires are not caught by the moving parts of a machine or sport equipment. This could lead to damage or injury (e.g. if loops are formed in the cable lead wires).
- Take care to prevent chemicals/liquids from entering the connectors or internal part of the NR device.
- Any attempt to use cleaner containing organic solvent, thinner, toluene, or benzene for cleaning of the NR device will generate the damage of the housing.
- When cleaning NR device, wipe with a cloth soaked with regular household cleaner diluted with water.
- Do not polish the housing with abrasive or chemical cleanser.
- For all but NR-314P models: do not, under any circumstances, insert objects in the ECG Connector slot, SD card slot or the battery compartment other than NR ECG Cable connector, SD memory cards or appropriate batteries. This may lead to damages to the NR device and endanger the patient.

**Note**

- For all but NR-314P models: use only a Norav Certified SD card for Recording.
- It is the end user's responsibility to properly configure the NR device with settings that are compatible with their ECG analysis software.
- False positive and false negative pacers detects may occur when using Pacer Detect. False positives - may result from poor electrode connection to the patient or a large amount of electrical interference from nearby objects. False negatives - may occur with pacers that are bipolar because of a weak pacer pulse signal at the patient's skin.
- The NR device is not designed for emergency purposes (intensive medical). It is only designed to record the ECG and/or heart rate.

Device Controls and Indicators

Models: NR-302, NR-314, NR-314-T, NR-1207, NR-1207-3 and NR-1207-E

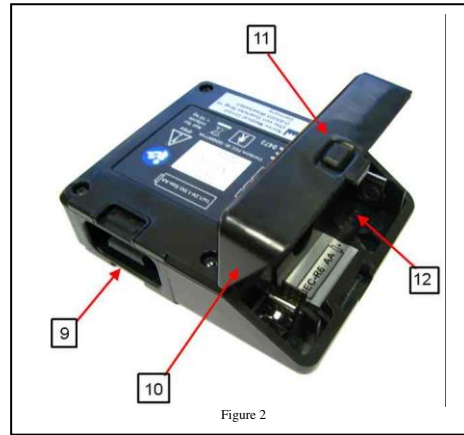
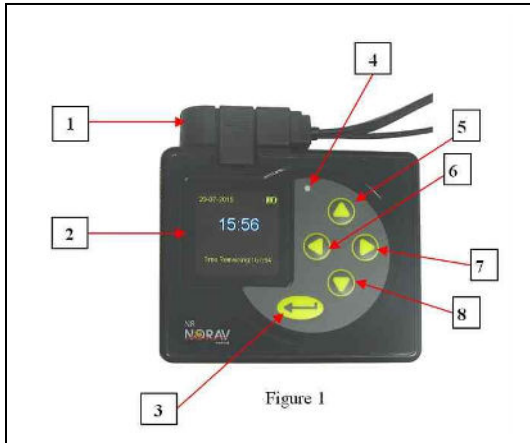

Element	Description
1	Patient ECG Cable connector
2	Screen to display feedback from the NR device
3	Enter, Event button
4	Green led Indicator , Voice device microphone
5	Up button
6	Left button
7	Right button
8	Down button
9	ECG cable connector slot
10	Battery and SD Flash card compartment door
11	Battery and SD Flash card compartment cover latch
12	Battery and SD Flash card compartment

Model NR-314P

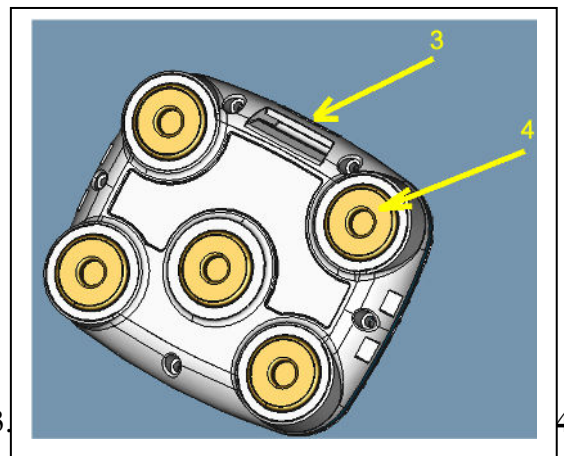
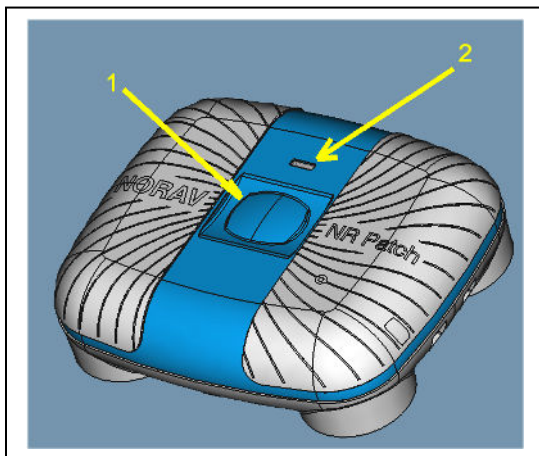

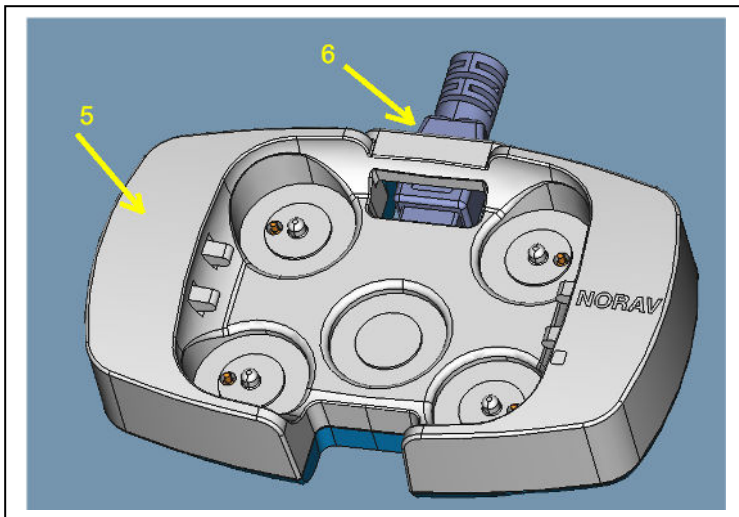

Element	Description
1	Power ON/OFF or Event push button
2	LED indicator
3	Neck Strap assembly
4	5 Snap receptacles for standard adhesive electrodes
5	NR-314P Dock station
6	Detachable USB cable mini-USB to A-USB

NR-314P Main Battery and Dock Station Overview

NR-314P features an internal non-user-replaceable rechargeable lithium polymer battery. It includes a Docking Station and USB cable for PC connection, recharging, and Holter data upload. The battery fully recharges in 3.5 hours. Docking the NR-314P during Holter recording stops and closes the recording. A fully charged battery supports up to 14 days of Holter recording, but charging between patients is advised. Frequent users can keep the NR-314P docked between uses. For less frequent use, remove the NR-314P from the dock once charged and reconnect shortly before the next study for a quick recharge.

NR-314P will flash its LED indicator in blue during charging. After NR-314P internal battery is fully charged the LED will be solid blue light. After disconnection of NR-314P from the Dock Station or removing USB power, the NR-314P will turn OFF itself.

	<ul style="list-style-type: none"> The Dock station shall connect only to computers that are complied with EN60950-1
<p>Caution</p>	

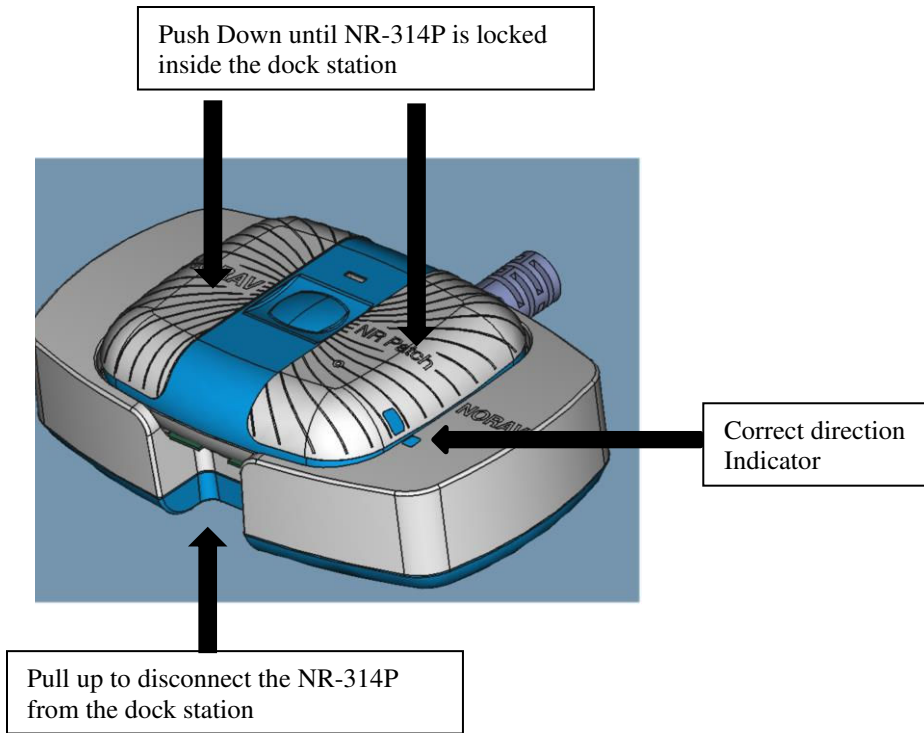

Memory Card Usage (SD card)

Models: NR-302, NR-314, NR-1207 and NR-1207-3

The SD (Secure Digital) card, formatted for recording biological information, is an IC card with electrically erasable, non-volatile flash memory. This ensures data retention without power, eliminating the need for backup batteries.



Open battery compartment cover by moving Left and Up the battery compartment cover latch.

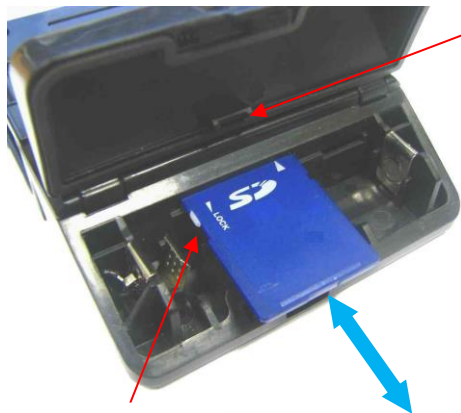



Memory card Retainer

The memory card slot is a "push-push slot." Insert the memory card by pushing it into the slot until it locks. To remove, push the card 1-2 mm into the slot to unlock it. Remove the battery before inserting or removing the SD card. The battery compartment cover includes a retainer to secure the memory card during recording.

Write-protect notch, Unlocked state shown

 Caution	<ul style="list-style-type: none"> • The NR device is mechanically protected from an incorrect insertion of the memory card. Do not force the card into the slot. • Using the memory cards with other instruments (digital cameras, MP3 players, etc.) can lead to incorrect functioning and/or data loss. • If memory card is not completely locked inside its slot, the card retainer (part of battery compartment cover) will not allow to close the cover. Do not push the cover when closing with force; it can damage the card and/or the card slot.
---	---

 Note	<ul style="list-style-type: none"> • When looking at the SD card from the top, on the left side, there may be a write-protection notch. If notch is not in Unlocked state, slide the tab upward (Toward the contacts) to declare the card read/write enabled. • If the storage space runs out during a recording, the recording is stopped automatically and the instrument switches off.
--	---

 Note	<ul style="list-style-type: none"> • Use only a Norav Certified SD card for Recording. • The NR device supports only SD cards formatted as follows: FAT(FAT16) with cluster size = 64KB for SD cards ≤ 4G or FAT32 with cluster size = 64KB for SD cards > 4G 	
--	--	---

Main Battery

Models: NR-302, NR-314, NR-314-T, NR-1207, NR-1207-3 and NR-1207-E

The NR is powered by one 1.5 volt AA Alkaline battery (IEC-LR6), one 1.2 volt AA rechargeable Nickel-Metal Hydride (NiMH) battery (IEC-HR6), or one 1.5 volt AA Li-FeS2 Lithium battery (IEC-FR6).

Although battery life may last longer than a recording, batteries should not be re-used for a second patient. After one use, they should be disposed of following local ordinances.

How to Insert Battery



Insert a fresh AA battery as indicated in illustration, be sure to first insert from the negative terminal. Pay special attention to the correct polarity of the battery



As indicated in the illustration, close battery compartment cover and press on it until latches into the base part.



Caution

- Check that NR device settings showing a correct Battery type in the setup of the NR device.



Caution

- Do not leave battery in the NR device for extended periods (more than two weeks) when the NR device is not in use.
- If you use rechargeable batteries, the battery recharger should be kept out of the patient environment and hook-up area.
- Dispose of used batteries carefully, using environmentally friendly methods wherever possible following the state's recycling laws or your facility's recycling policy

RTC Back up Battery

Models: NR-302, NR-314, NR-314-T, NR-1207, NR-1207-3 and NR-1207-E

The NR real-time clock is maintained by an internal rechargeable lithium cell, charged during recording from the main battery. With a full charge, the clock is maintained for at least 4 months after the main battery is removed. The clock cell is not replaceable by the user, and in the case of suspected failure the NR should be returned to Norav for service.

Electrode Application Guide



Note

Many ECG adhesive electrodes are suitable for use. As ECG electrodes from different manufacturers have different electrical properties, the choice of ECG electrodes can considerably affect the measurement results and quality. Ensure that only high-quality electrodes are used. Wet gel electrodes are recommended.

Always refer to the ANSI/AAMI EC12:2000 Standard for safety, performance, and labeling requirements for the disposable electrodes, and guidelines for reliable patient connections.

Prepare the patient's skin prior to applying the electrodes. Skin is a poor conductor of electricity, so skin preparation is important in achieving good electrode-to-skin contact.

- If necessary, clip hair at the electrode sites (or shave sites, if needed).
- Clean and abrade the skin at the electrode sites to remove oil and dead skin.
- Wash the skin thoroughly with soap and water.
- Dry the electrode placement sites.

Attaching Electrodes

- Attach the leads and the electrodes before placing the NR device on the patient.
- Apply the electrodes by peeling them, one at a time, from the protective backing and sticking them firmly to the patient's skin.
- The offset connector tab should be positioned in the same direction as the lead wires, towards the equipment.
- For NR-314P model only: optionally use neck strap to prevent the device fall during recording.
- Place the electrode on the skin by gently pressing around the edge. For wet gel always avoid pressing down the center of the electrode. If in doubt refer to the directions on the reverse of the pouch.

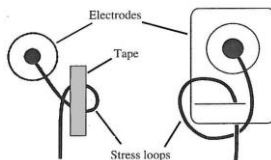

If you use lead lock or clip lock electrodes, be sure to use the lock or clip to relieve stress on each lead wire.

Otherwise, tape each lead wire into a stress loop to help prevent movement of the electrode.



WARNING

- As you attach electrodes, be careful to not let any unattached electrode come in contact with other conductive objects, including ground.
- Leave 1.5 meters (5 feet) of open area around the patient during NR device hookup and removal.
- Do not connect external devices to NR device. Connect patient lead wires only to patient electrode.
- Keep the NR device and patient cable clean, especially the components that touch patients.
- Do not use electrodes for adults on children.
- Before each recording and before attaching sensors or electrodes to the patient, check the casing and the ECG patient cable for damage which may have occurred, for example, due to mechanical overload, falling from a great height or wear and tear (chafed patches on the cable). Do not use the instrument or the cable if you detect cracks, melted areas or any other signs of damage to the cable or housing.



Caution

- Verify that dates on applicable accessories have not expired.
- ECG electrodes can cause skin irritation. Examine skin for signs of irritation or inflammation and avoid placement of electrode in those areas. If skin irritation occurs during the procedure advise the patient to remove the electrodes and contact the health service provider as soon as possible.
- All electrodes should be of the same brand and type, to minimize noise.



Note

Excessive sweating can cause the electrodes to slide, become loose, fall off, and shorten wear time. It is recommended showering briefly with patient back to the water and avoid any activities that cause excessive sweating.

Electrode Placement Scheme

Suggested electrode placements are shown in the diagrams below. However, it is up to the physician to make the final placement determination. The NR device's ECG display screen or Computer Analysis System that used Bluetooth communication can be used to verify a proper patient hookup.



Caution

- Do not rely on the NR device LCD display as a diagnostic tool.

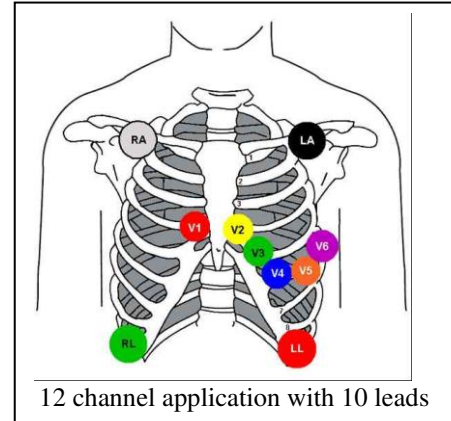
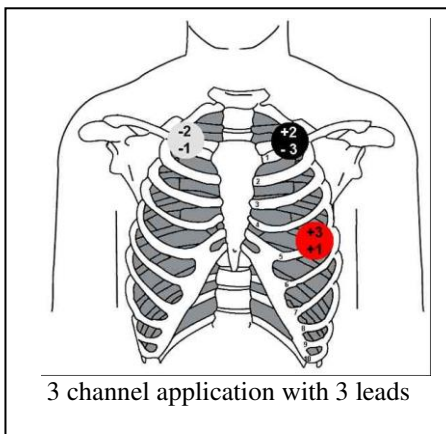
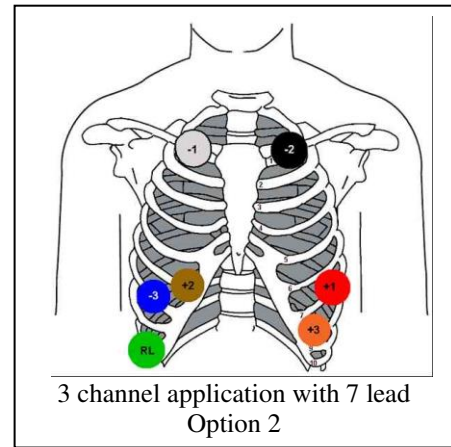
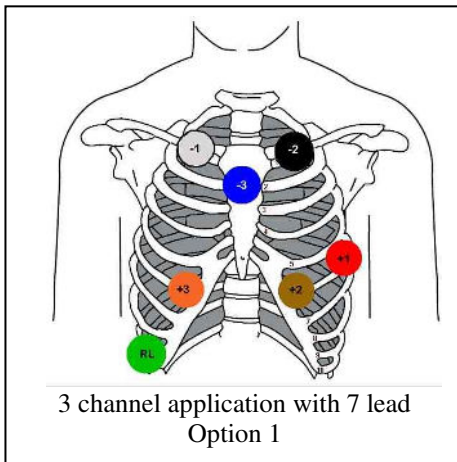
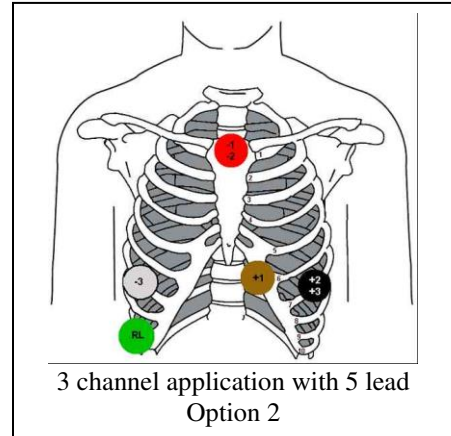
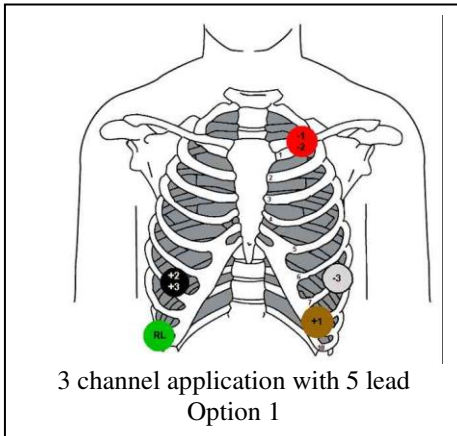

Patient Cable Connection

Models: NR-302, NR-314, NR-314-T, NR-1207, NR-1207-3 and NR-1207-E



Connecting:

Insert the Patient ECG Cable connector into ECG cable connector slot of the NR unit, as shown on the picture. Make sure to insert the Cable connector until there is no space between the Cable connector and the unit.

Make sure that two latches of the Cable connector are latching with the unit.

Disconnecting:

Remove the Patient ECG Cable connector by squeezing the two side latches on the head of the Cable connector and pulling away from the connector slot of the NR unit.



Caution

- Be careful not to connect the Patient ECG Cable connector upside down or at an angle into the ECG cable slot on the NR unit. This may result in damage to both the Cable connector and the ECG Cable input slot of the unit.
- Do not insert into the ECG Cable slot on the NR any other than the Patient ECG Cable connector. Damage can result to the both the ECG Cable slot input connector and Patient ECG Cable connector.
- Always check the presence of sealing O-ring on Patient ECG Cable connector and its quality. O-ring sealing protects the NR unit against ingress of splashing water when the Patient ECG Cable connector is fully fitted into the unit.
- During recording, make sure that the cable lead wires are not caught by the moving parts of a machine or sport equipment. This could lead to damage or injury (e.g. if loops are formed in the cable lead wires).
- NEVER pull on the cable itself because this can easily break the wire inside the insulation. Pulling on the cable also can cause a noisy and intermittent ECG recording.



Note

NR hardware includes Cable connected sense. If NR device will not detect connected Cable, it will display warning message with buzzer beep and show diagram of unit with not connected Cable connector.

Screen Navigation

Models: NR-302, NR-314, NR-314-T, NR-1207, NR-1207-3 and NR-1207-E

The NR device features menus for setting preferences and entering patient data, navigated using four keys: left, right, up, and down. Selections are made with the Enter key. The device operation involves a sequence of steps: setting Record Mode, checking/setting Date & Time, entering Patient Identification, checking ECG signal quality, and starting Recording. Users interact with the NR device via various LCD screens and five push-buttons.



- To prevent possible damage to the keypad, do not use sharp or hard objects to depress keys.

Caution

Screen	Description
Main	Displays Current date/time, Main battery level, and following Menu items : <ul style="list-style-type: none"> • Patient Data <i>(Display Patient data – ID or Name)</i> • Voice Recording <i>(Record operator voice message - up to 20seconds)</i> • Recording Settings <i>(Display enabled recording settings)</i> xxxH = Record time in hours \E = Event button enabled \P = Pacemaker detection enabled \R = Respiration enabled \A = Acceleration sensor enabled
Settings	Displays Menu items: <ul style="list-style-type: none"> • Patient Settings <ul style="list-style-type: none"> ➤ ID <i>(Change via Virtual keyboard screen)</i> ➤ First Name <i>(Change via Virtual keyboard screen)</i> ➤ Last Name <i>(Change via Virtual keyboard screen)</i> ➤ Birthday <i>(Change via Virtual keyboard screen)</i> ➤ Clinic ID <i>(Change via Virtual keyboard screen)</i> ➤ Display Format Patient ID, Clinic ID, Name <i>(Select patient data field to display on the Main screen)</i> • Record Settings <ul style="list-style-type: none"> ➤ Record Time 24,48,72,96,120,168, 336 hr <i>(336 hours option is limited to 3 channel mode with 3, 4 , 5, 7 lead cable , 250 sample rate and Lithium battery only)</i> ➤ Sample Rate (of ECG) 250,500,1000<i>(samples per second)</i> ➤ Pacemaker detection ON or OFF <i>(OFF by default. Once turned ON remains active within the current recording only)</i> ➤ Accelerometer ON or OFF ➤ Respiration ON or OFF <i>(always OFF when Pacemaker detection is ON)</i> ➤ Diary OFF , Event button, Symptom list, Voice note <i>(in Holter/Holter+ mode)</i> <ul style="list-style-type: none"> ■ Event button - Save Event for each button press ■ Symptom list – Select a symptom from list on the Display ■ Voice note - Record a Voice note ➤ Voice note ON or OFF <i>(When ON - allow to record a Voice note) (for NR-1207-3 model in ECG+ mode)</i>

Screen	Description
Settings (<i>continue</i>)	<ul style="list-style-type: none"> • System Settings <ul style="list-style-type: none"> ➤ Date\Time <ul style="list-style-type: none"> ■ Date (Month,Day,Year) ■ Date Format (MM/DD/YYYY, YYYY/MM/DD, DD/MM/YYYY, YYYY/DD/MM) ■ Time (Hour and Minute) ■ Time Format (12 or 24 hr) ➤ Display <ul style="list-style-type: none"> ■ Contrast (20-90%) ■ Rotation (0, 90, 180, 270 deg.) ➤ Battery <ul style="list-style-type: none"> ■ Alkaline ■ NiMH ■ Lithium ➤ Language <ul style="list-style-type: none"> ■ English ■ Español ■ Deutsch ■ Français ■ Italiano ■ Português ■ Nederlands ■ Polski ■ Русский ■ Ελληνική ■ Türk ➤ Mode (for NR-1207-3 model only) <ul style="list-style-type: none"> ■ Holter ■ Holter+ ■ ECG ■ ECG+ • Save as default (Press Enter to save as default current settings) • About (Press Enter to see NR device information – Model, Serial number etc.)
Lead check	Displays the connection status of each lead
ECG CH1,CH2,CH3 or I,II V6	Displays real-time ECG signal, pacemaker pulse marks, and gain setting. Change the gain using the keypad's up/down buttons; available settings are 0.5, 1.0, 2.0, 4.0, 8.0. Gain affects only screen display, not recording, which is always at 1.0x gain. At 1.0x, grid size is 10 mm/mV (two boxes = 1 mV). With Pacemaker Detection on, pacemaker pulse marks appear below the trace for each detected pacemaker pulse.
Start	After configuring or reviewing all the settings, select the start screen and press <i>Enter</i> . This will start the recording. During recording, the NR device displays the current time and time remaining to record.
Info	During recording NR device will display the date, current time, battery level indicator and time remaining for the recording.

“Main” menu screen - explanation of menu navigation by using keypad buttons almost the same for the others menu screens.

The screenshot shows the 'Main' menu screen with the following elements and callouts:

- Menu Item[1]: Patient ID**: Points to the 'Patient ID:' label.
- Recorder Date&Time**: Points to the date and time '03-08-2015 10:00'.
- Main Battery Indicator**: Points to the battery level icon.
- Menu Item[2]: Voice Record**: Points to the 'Voice Record' option, which is highlighted. The text below explains: 'Selected Item is highlighted in current Menu Screen. Navigate to above or below menu Item by using up/down buttons of the keypad.'
- Menu Item[3]: Recording settings**: Points to the '168H / E' value. The text below explains: 'Record Time = 168Hr, Event Button = On'.
- Help line text meaning:** 'Navigate to the Next/Previous Menu screens by using left/right buttons of the keypad' points to the left and right arrow keys.
- Help line text meaning:** 'To start Voice Recording Press Enter button of the keypad' points to the 'Press Enter to start' instruction.

“Virtual Keyboard” menu screen (alphabet layout with lower case shown), used to enter Patient Data like ID, First Name etc. Use up/down/left/right buttons of the keypad to navigate via the virtual keyboard screen items.

The screenshot shows the 'Virtual Keyboard' menu screen with the following elements and callouts:

- Entered characters**: The string 'Thomas_' is shown at the top. The text below explains: 'This line shows entered characters from the virtual keyboard. This character string will be saved if select item "Save" at the bottom of the screen and pressing Enter button of keypad.'
- Selected character**: The character 's' is highlighted. The text below explains: 'Selected character is highlighted – press Enter button of keypad to insert it to the string at line above. Navigate with up/down/left/right buttons of the keypad to select different character'.
- Virtual keyboard control icons line**: A row of icons for keyboard control. The text below explains: 'Virtual keyboard control icons line. Meaning of the icons from left to right: Select - upper or lower case alphabet keyboard layout, Select - Space character, Select - Backspace character, Select - Numeric keyboard layout, Select - Alphabet keyboard layout, Select - Extended alphabet keyboard layout'. A note states: 'Note: Alphabet and extended alphabet layout depends on system language of the recorder'.
- Navigation**: The 'Save' and 'Cancel' buttons are at the bottom. The text below explains: 'Navigate here with up/down/left/right buttons of the keypad to Save or Cancel the entered string at the top of the screen'.

Common Modes and Workflows

Holter mode (for NR-302/314/1207/1207-3 and NR-314P models)

A basic workflow for “classic” Holter recording procedure.

- Prepare NR device.
- Enter patient information.
- Hookup patient
- Check ECG leads quality.
- Start recording.
- While recording continues enter diary events by patient.
- When patient bring the NR device back stop the recording.
- Download the ECG recording file to the computer.
- Preview/Analyze the ECG in Holter software interface.

Holter+ mode (for 1207-3 and NR-314P models)

Advanced workflow allowing to acquire the ECG traces online while Holter recording is continues.

- Prepare NR device.
- Enter patient information.
- Hookup patient
- Check ECG leads quality.
- Start recording
- Acquire the live ECG every time when it is necessary
(*patient must be near to the acquisition workstation*)
- While recording continues enter diary events by patient (optional).
- When patient bring the NR device back stop the recording.
- Download the ECG recording file to the computer.
- Preview/Analyze the ECG in Holter software interface.

ECG mode (for NR-314-T/1207-E/1207-3 and NR-314P models)

Standard workflow for PC-ECG acquisition.

- Prepare NR device.
- Hookup patient.
- Check ECG leads quality.
- Run the PC-ECG or Mobile ECG software application and enter patient information.
- Acquire the live ECG.

ECG+ mode (for 1207-3 model only)

Advanced mode for record continuously the ECG traces in the NR device memory independently to live ECG is acquiring or not. Allows to store ECG records for more than one patient on the same memory card.

- Prepare NR device.
- Enter the patient information.
- Hookup the patient.
- Check ECG leads quality.
- Start ECG recording to the NR device memory card.
- Every time when it need - launch the PC-ECG or Mobile ECG software and acquire the live ECG.
- At the end testing of current patient – stop (pause) the ECG recording.
- Hookup the next patient and then continue the recording in the NR memory card.
- When NR memory card is filled – download the full disclosure ECG data to the computer.

ECG Recording Procedure: Detailed Instructions

Models: NR-302, NR-314, NR-314-T, NR-1207, NR-1207-3 and NR-1207-E

Starting New Test

1. Prepare NR device

- Open NR device battery compartment door.
- Insert an SD card into NR device. *(Skip this step when use models NR-1207-E and NR-314-T.)*
- Insert a new battery and close the battery compartment door.
(Green LED of the keypad will start flashing once per second)
- Prepare the patient *(the patient should already be connected to the electrodes and patient leads)* and connect the ECG cable connector to the NR device unit.
- Turn on the NR device by pressing the *Enter* button of the keypad.

2. Enter Patient Information (for Holter, Holter+ and ECG+ mode)

If the NR device is loaded with an SD card containing the Patient Data\Recording Settings file, it will load this data. Verify patient data (ID, Name, etc.) on the LCD screens. If data is incorrect or missing, enter it via LCD menu screens and keypad. For voice record-enabled models, record patient data using the voice record option on the “main” screen for clear identification. Recordings can last up to 20 seconds. Ensure the microphone (indicated by Green LED on keypad) is near your mouth and speak at a normal volume. Check and modify recording settings as needed.

3. Check ECG Leads

Verify each channel's signal quality and amplitude through the ECG screen menus. If ECG waveforms are unsatisfactory, reposition electrode sites with new electrodes as described earlier in this manual. Instruct the patient to stand, sit, and lie down to check the ECG signals. Have the patient walk in place and ensure no artifacts or muscle noise appear on the NR device LCD screen. If issues persist, inspect stress loops and re-prepare hookup sites with new electrodes.

4. Start Recording (for Holter, Holter+ and ECG+ mode)

- Start the ambulatory ECG recording from the “Start” screen by pressing the Enter button.
- The LCD displays the “Recording” screen, showing date, time, battery level, and recording time left. If inactive, the screen blanks out but reactivates upon button press.
- Secure the NR device on the patient in a pouch or holster, ensuring only electrodes and some lead wires are in direct contact with the skin. Position the device for easy access to the Enter button and clear view of the LCD.
- Inform the patient to keep the NR device and electrodes dry; avoid showering, bathing, or swimming during the test.
- Teach the patient to use the Enter button for noting symptoms or important activities. For diary entries, use up/down arrows for selection, or voice record for voice-enabled models.

Acquire ECG Online (for Holter+, ECG and ECG+ mode)

In Holter+ mode, the NR-1207-3 NR device transmits live ECG traces online. Use the Resting ECG software of PC-ECG 1200 or Mobile ECG app for Android OS, following the respective user manual..

Enter Diary Event (for Holter, Holter+ mode)

Press and hold the Enter button on the NR device. Follow the configuration to select a symptom from the list or add a voice note.

Add New Patient Marker (for ECG+ mode only)

During an ECG Recording ('REC' flashing on Lead Check screen), press and hold the Enter button to increase the patient counter and add a voice note if enabled.

Stop/Pause/Restart ECG Recording (for ECG+ mode only)

During an ECG Recording, press both left and right arrow buttons simultaneously. In the record control menu, choose:

- “**Stop ECG**” - to pause the recording (finish for current patient).
- “**Overwrite Record**” - to clean the memory card and restart recording.
- “**Shutdown**” - to turn off the NR device before removing the memory card and downloading the ECG recording to the computer.

Stop Holter Recording (for Holter and Holter+ mode)

Automatic shutoff occurs when recording duration is complete or battery is low. Manually stop by pressing both keypad buttons for 3 seconds.

Data Downloading

After session completion:

- 1) Remove the electrodes from the patient.
- 2) Remove the battery from the NR device.

For ECG data analysis:

- 1) Remove the memory card and transfer data using a card reader of the Computer Analysis System and transfer the ECG data according to the manual of this System.
- 2) Optionally, download directly via USB without removing the card. Replace the patient cable with USB cable, ensuring the card is in the NR device. Connect the USB to a computer; the NR device functions as a card reader.

After data transfer, erase ECG data from the memory card for reuse.



Note

- The NR device with installed battery and SD card, turned ON and ECG cable connector connected to the unit; and is left for 10 minutes without pressing any button of keypad, will start the test automatically (*for Holter and Holter+ modes*). This feature of the device shall eliminate the risk that the operator forgets to start the test.
- The NR device with installed battery and SD card, turned ON and ECG cable connector connected to the unit; and detects a recording saved on the memory card which has not yet been downloaded by the Computer Analysis System, will show warning message screen and will offer an option to erase the old record and prepare the device for a new record on the same memory card.
- If the batteries run flat during a recording, it is necessary to replace them with fully charged batteries within 1 hour. If the batteries are replaced in time, the NR device will resume the recording. However, the device will not continue in the test, if the batteries are not replaced in time. The data recorded before the battery runs flat are stored in the memory card and can be freely accessed and analyzed after download by Computer Analysis System.
- The NR device will only allow you to select settings for a recording what will fit on the SD flash card. There is a relationship between the record time, sample rate, and number of channels. By choosing a higher value in one setting, you may have to choose a lower value than you want in another setting. It is best to first set the lowest setting you desire, then the second highest, and so on.

Model NR-314P

Start New Recording

To start a new recording, connect the NR-314P to the dock station and use the Setup Software on the Computer Analysis system to enter patient demographics and recording parameters. After downloading settings to the NR-314P, disconnect it from the dock station and power it on. Observe the LED changing from fast flash to solid green, indicating completion of the initialization. To begin recording, press the button for 3 seconds until the LED starts slow flashing, then release. Recording starts after 30 seconds, and the LED turns off after 60 seconds.

Recording in Progress: Available Actions

A short press on the button will light the LED blue for 2 seconds. Holding the button for 3 seconds records a user event; the LED stays blue for 15 seconds before turning off.

Stop Recording

Recording stops automatically when the set duration is reached or battery is low. To stop manually, hold the push button for 15 seconds.

Data Downloading

After recording, remove the electrodes, disconnect the NR-314P, and connect it to the dock station. The flashing blue LED indicates the NR device is in card reader mode. Transfer the ECG data like a removable disk drive, then erase the NR-314P's internal memory for the next patient.

	<ul style="list-style-type: none"> • The NR-314P turned ON; and is left for 10 minutes without pressing button, will start recording automatically. • The NR-314P turned ON; and detects a recording saved on the memory which has not been downloaded to the computer yet, will turn ON LED solid RED for 5 sec and turns OFF.
Note	

Switching Device ON/OFF

To turn on the NR-314P, press the button for 2 seconds and release it; the LED will fast flash green. Once the NR-314P finishes internal initialization, the LED turns solid green. To turn off, press and hold the button for 15 seconds until the LED turns off.

Maintenance and Cleaning



Cleaning and Disinfection for devices and patient lead wires

* Before the Cleaning and Disinfection process, remove the battery.

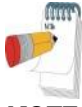
	<p>Before cleaning any part of the equipment, disconnect the equipment from the power supply and disconnect the device from any other equipment or external devices.</p>
WARNING	

 Caution	<p>Take care to prevent chemicals/liquids from entering the connectors or internal part of the device. The battery contacts should not come in contact with soap or water. Do not polish the housing with abrasive or chemical cleansers. Use of alcohol, acetone, Alkyl Dimethyl Benzyl ammonium chlorides, or methyl ammonium chloride is NOT recommended to clean the reorder unit and holster. Use of alcohol or acetone on lead wires could cause the lead wires to stiffen and the insulating plastic to crack. Use of methyl ammonium chloride (commonly found in many consumer wipes) on the device unit and accessories could cause the plastic to deteriorate. The device and patient lead wires must NOT be autoclaved or sterilized with steam.</p>
 NOTE	<p>If liquid penetrates the device, i.e., during cleaning or operation, this may interfere with correct functioning. Switch the device OFF and remove the battery. Leave the device in a warm, dry room with the battery door open for 48 hours. If the functioning is still affected, contact the contact customer support.</p>

ECG Device Surfaces/Patient Cables/Leadwires

Level of Reprocessing	Low-level disinfection
When	Immediately after use
Pretreatment	Wear disposable gloves.
 Manual Cleaning	<ol style="list-style-type: none"> 1. Use a soft non-abrasive damp cloth with tap water, wipe the device for at least 30 sec., repeat as necessary or until there are no residues of soil and dirt on the device. 2. Prepare a neutral/mild pH enzymatic detergent, according to the manufacturer’s instructions (in the lowest recommended concentrations). Effective cleaning can be achieved by using Deconex Power Zyme, prepared using concentration of 1% (20 ml per 2 liters of water) with tap water. 3. Immerse the soft non-abrasive damp cloth with the prepared detergent, then wipe the device for at least 30 sec. Repeat as necessary or until there are no residues of soil and dirt on the device. 4. Finally, use Isopropanol 70% wipes to clean the device for at least three (3) minutes.
 Disinfection	<p>After the cleaning procedure is completed, perform the disinfection procedures as follows: Use Isopropanol 70% wipes to disinfect the device for at least three (3) minutes. Repeat as necessary.</p>
Drying	Dry for ten (10) minutes.

Maintenance

Before using the NR device, execute the check of the unit in accordance with the check procedure. In case any rejected items are found as a result of the check, it will be totally judged as rejection. Take the corrective measures for the rejected items. Use the NR device after all the items become accepted. Unit check shall be performed by each medical institution, or by Norav personnel, representative agent, or an authorized third party. For more details, do not hesitate to consult your dealer or Norav Medical personnel.

Details of the check	Check Method	Criteria
Operation manual	Check that the operation manual is kept in a predetermined place.	Should be kept in a predetermined place.
Cracks and distortion of the NR device enclosure	Visually check the NR device enclosure for cracks and distortion.	Must be free from cracks and distortion.
Keypad buttons	Check whether the keypad buttons have tactile feedback when pressed	Must get tactile feedback.
Battery contacts in the battery compartment	Visually check the battery contacts for strain, skew, and corrosion.	Must be free from strain, skew, and corrosion.
Battery compartment door latch	Check spring loaded in the battery door latch.	Spring must be loaded.

Battery compartment	Check whether dirt or hair is not accumulated between the battery compartment and its door	Must be free from dirt or hair.
SD card	Visually check for scratches and damage.	Must be free from scratches and damages.
ECG Snap Buttons	Visually check for damage and corrosion	Must be free from damages and corrosion.

Storage

Before storage, make sure to remove the main battery and a SD card from the NR device and close the battery compartment door tightly. Store the NR device in the provided storage case.

 Caution	<ul style="list-style-type: none"> • Store the NR device in an area free from water or humidity. • Take care to avoid areas subject to high humidity, poor ventilation and direct sunlight; store the NR device in an area free from any adverse effects of surrounding air containing dust, sodium, and sulfur. • Do not store the NR device in an area where chemicals are kept, or which is exposed to chemical fumes or vapors.
---	--

Service

If there is a problem with the NR device, review the Troubleshooting section for a listing of problems and solutions. If additional assistance is required, contact customer support via phone, fax or e-mail listed in this manual. Call customer support before returning a NR device to make shipping arrangements.

All repairs on products under warranty must be performed or approved by Norav Medical. Unauthorized repairs void the warranty. In addition, whether or not covered under warranty, any product repair shall exclusively be performed by Norav Medical certified service personnel.

When calling, please be prepared to provide:

- Product name and complete description of the problem.
- Serial number of your product.

In case a return cannot be avoided, the representative will record all necessary information and will provide a Return Material Authorization (RMA) number, as well as the appropriate return address. An RMA number must be obtained prior to any return.

If you have to return goods for service, follow these recommended packing instructions:

- Remove all cables, sensors, and ancillary products (as appropriate) before packing, unless you suspect they are associated with the problem.
- Wherever possible use the original shipping carton and packing materials.
- Include a packing list and the Norav Return Material Authorization (RMA) number.

It is recommended that all returned goods be insured. Claims for loss or damage to the product must be initiated by the sender.

Calibration

The device does not need any calibration.

Troubleshooting

Models: NR-302, NR-314, NR-314-T, NR-1207, NR-1207-3 and NR-1207-E

Symptom	Solution
No display or NR device does not power on	<ul style="list-style-type: none"> ■ Ensure battery is inserted with correct polarity. ■ Install a new AA battery.
Low battery (<i>message</i>)	<ul style="list-style-type: none"> ■ Install a new AA battery. ■ Inspect battery compartment, clean contacts if necessary.
No Cable (<i>message</i>)	<ul style="list-style-type: none"> ■ Ensure patient cable (lead set) is connected to the NR device. The NR device will not pass the screen unless a cable is connected. ■ Check that the NR device sided connector is not damaged. ■ Check that the cable connector pins are not broken or bent / damaged.
Noise artifacts on ECG signal	<ul style="list-style-type: none"> ■ Ensure you have prepared the patient’s skin according to the instructions. ■ Ensure the electrodes are properly applied to the patient. ■ Ensure the leads are making proper contact with the electrodes. ■ Replace the Patient ECG cable.
Lead OFF (<i>message</i>)	<ul style="list-style-type: none"> ■ Ensure you have prepared the patient’s skin according to the instructions. ■ Ensure the electrodes are properly applied to the patient. ■ Ensure the leads are making proper contact with the electrodes. ■ Replace the Patient ECG cable.
SD Card Error (<i>message</i>)	<ul style="list-style-type: none"> ■ Ensure the memory card is Norav Certified. ■ Ensure the memory card is not write protected (small switch on the SD Card) ■ Reformat the memory card or replace the card with a new Norav certified memory card.
Previous recording found (<i>message</i>)	<ul style="list-style-type: none"> ■ Download the ECG data with Computer Analysis System, or delete it from the SD card using left and enter buttons.
Set Date/Time (<i>message</i>)	<ul style="list-style-type: none"> ■ The internal battery that runs the real time clock may not be fully charged. This battery is built into the NR device and is not user replaceable. It is recharged every time you insert an AA battery. If the NR device is unused for an extended period of time, the internal battery can become discharged. To fully recharge the internal real time clock battery, insert a fresh AA battery into the NR device and let the NR device charge, for 12 hours.
SD card too small (<i>message</i>)	<ul style="list-style-type: none"> ■ Check that Record Settings screen is set for the desired number of hours. Memory card has only enough memory capacity to run for the number of Hours which are available as valid selections in the Record Settings menu.

Model NR-314P

Symptom	Solution
NR device does not power on	<ul style="list-style-type: none"> ■ Ensure that the NR-314P is fully charged
RED LED is ON when not connected to dock station	<ul style="list-style-type: none"> ■ Ensure previous record file downloaded to Computer Analysis System and Removed from the internal memory of the NR-314P. ■ Ensure RTC set correctly via Computer Analysis System
RED LED is ON when connected to dock station	<ul style="list-style-type: none"> ■ Use only Norav USB cable, try replacing USB cable. ■ Try connecting USB cable to other USB port or to another computer
BLUE LED is OFF when connected to dock station	<ul style="list-style-type: none"> ■ Use only Norav USB cable, try replacing USB cable. ■ Ensure USB cable is connected to powered-on computer ■ Ensure NR-314P connected correctly to the dock station
Connected to dock station but NR device drive not visible on the computer	<ul style="list-style-type: none"> ■ Use only Norav USB cable, try replacing USB cable. ■ Try connecting USB cable to other USB port ■ Ensure NR-314P connected correctly to the dock station

Technical Specifications

Models: NR-302, NR-314, NR-314-T, NR-1207, NR-1207-3 and NR-1207-E

	Conditions	min	typical	max	Unit
Dimensions					
Width			92		mm
Height	Without ECG cable		75		mm
Depth			23		mm
Weight	Without battery		103		g
Ingress protection against water	With ECG cable connected, Battery door closed, and sealing installed.		IP22		
ECG					
Channels		3		8	
Input impedance		>10			Mohm
CMRR		>90			dB
Frequency Response HPF	Recording		0.05		Hz
Frequency Response LPF	Recording	65		260	Hz
Dynamic range	Recording, peak to peak		10		mV
A/D bit Resolution	Recording		12		bit
Sampling rate	Recording	250		1000	Hz
Pacemaker detection	Analogue detection on 2 channels				
	Amplitude	2		700	mV
	Width	0.1		2	ms
Accelerometer					
Channels			3		
Dynamic range	Recording, peak to peak		4		g
Respiration					
Channels	Sensing electrodes ch1+,ch1-		1		
Excitation current			27.3		uA
Excitation frequency			64		kHz
Power					
Supply voltage	1x AA battery	1.0	1.5	2.7	V
Internally occurring voltage			2.8	13	V
In RMS current during recording	Vbatt=1.5V	10		150	mA
Ambient conditions					
Ambient temperature	Storage	-20		+60	°C
	Operation	+10		+45	°C
Humidity (non-condensing)	Storage	10		95	%RH
	Operation	10		95	%RH
Atmospheric pressure	Storage	700		1060	hPa
	Operation	700		1060	hPa

Conformance to Regulatory Standards	IEC 60601-1, IEC 60601-1-2, IEC 60601-2-25, IEC 60601-2-47, IEC 60601-1-11
Classification	Type-BF applied part (NR-314, NR-302, NR-1207), Defibrillation-Proof Type CF Applied Part (NR-1207-3, NR-2017-E, NR-314-T), Internally powered equipment, Equipment for continuous operation
Communication	USB 2.0 HS, Bluetooth 2.1+EDR Class1

Model NR-314P

ECG	
ECG Channels	3 channels
Recording capacity	2GB
Input impedance	>10 Mohm
CMRR	>90 db
Dynamic range	10mV p-p
Maximum DC input	800mv p-p
A/D bit resolution	12bit (24-bit acquisition)
Pacemaker detection	Analog detection, 2-700 mV at 0.1-2 ms
Sampling rate	128,256,512 and 1024
Frequency response	128 Sampling rate: 0.05 – 25 Hz 256 Sampling rate: 0.05 – 51 Hz 512 Sampling rate: 0.05 – 102 Hz 1024 Sampling rate: 0.05 – 204 Hz
Recording Time (maximum)	128 Sampling rate: 14 days 256 Sampling rate: 9 days 512 Sampling rate: 7 days 1024 Sampling rate: 4 days
Accelerometer	
Channels	3 channels
Dynamic range	4g p-p
Physical	
Dimensions	47 x 55.5 x 17.8 mm
Weight	41g
Protection against objects and water ingress	IP64
Power	
Battery type	Lithium-ion polymer
Battery Capacity	700 mAh
Nominal Voltage	3.7V
Charging Voltage	4.2V
Battery life	500 recharges
Ambient conditions	
Operating Temperature	+5 to +45 °C
Storage Temperature	-25 to +70 °C
Operating Humidity	10 to 95 %RH
Storage Humidity	10 to 95 %RH
Operating Atmospheric pressure	700 to 1060 hPa
Storage Atmospheric pressure	700 to 1060 hPa

Conformance to Regulatory Standards	IEC 60601-1, IEC 60601-1-2, IEC 60601-2-47, IEC 60601-1-11
Classification	Type-BF applied part, Internally powered equipment, Equipment for continuous operation
Communication	USB 2.0 HS, Bluetooth Low Energy (BLE 5.0)

ECG Cables and Accessories

Models: NR-302, NR-314, NR-314-T, NR-1207, NR-1207-3 and NR-1207-E

Item	Part Number	NR Compatibility	Application	Defib. protected
ECG Cables				
3 Lead Patient Cable, Snap, AHA	C3-S-U-EI	302, 314, 1207, 1207-3	Holter	No
4 Lead Patient Cable, Clip, AHA	C4-C-U-EI-07	314-T, 1207-3, 1207-E	Telemetry, Stress	Yes
4 Lead Patient Cable, Clip, IEC	C4-C-E-EI-07	314-T, 1207-3, 1207-E	Telemetry, Stress	Yes
5 Lead Patient Cable, Snap, AHA*	C5-S-U-EI	314-T	Telemetry	No
5 Lead Patient Cable, Snap, AHA*	C5-S-U-EI	302, 314, 1207, 1207-3	Holter	No
5 Lead Patient Cable, Clip, IEC	C5-C-E-EI-07	1207-3, 1207-E	Rest	Yes
5 Lead Patient Cable, Clip, IEC	C5-C-E-EI-08	1207-3, 1207-E	Rest	Yes
5 Lead Patient Cable, Clip, AHA	C5-C-U-EI-07	1207-3, 1207-E	Rest	Yes
5 Lead Patient Cable, Clip, AHA	C5-C-U-EI-08	1207-3, 1207-E	Rest	Yes
7 Lead Patient Cable, Snap, AHA*	C7-S-U-EI	302, 314, 1207, 1207-3	Holter	No
7 Lead Patient Cable, Snap, IEC*	C7-S-E-EI	302, 314, 1207, 1207-3	Holter	No
10 Lead Patient Cable, Snap, AHA	C10-S-U-EI	1207, 1207-3	Holter	No
10 Lead Patient Cable, Snap, IEC	C10-S-E-EI	1207, 1207-3	Holter	No
10 Lead Patient Cable, Clip, AHA	C10-C-U-EI-07	1207-3, 1207-E	12-lead ECG	Yes
10 Lead Patient Cable, Clip, IEC	C10-C-E-EI-07	1207-3, 1207-E	12-lead ECG	Yes
10 Lead Patient Cable, Banana, AHA	C10-B-U-EI	1207-3, 1207-E	12-lead ECG	Yes
10 Lead Patient Cable, Banana, IEC	C10-B-E-EI	1207-3, 1207-E	12-lead ECG	Yes
Accessories				
USB 2.0 HS Cable, 1.5m	USBA-1.5M-EI	302, 314, 1207, 1207-3		
NR device Holster	NR-HOL	302, 314, 1207, 1207-3, 1207-E		
NR device Pouch	NR-P	302, 314, 1207, 1207-3, 1207-E		
Certified NR SD Memory Card 2GB	NR-2G-SD	314, 1207, 1207-3		
Certified NR SD Memory Card 512MB	NR-512M-SD	302		

* - To record the respiration signal, utilize either these 5-lead or 7-lead cables, as it cannot be captured with a 10-lead cable.

Model NR-314P

Item	Part Number
NR-314P dock station	NRP-USB-DOCKING-03
NR-314P neck strap	NECK-LANYARD-NRp-01
USB Cable A-to-B(mini) 1.5m	C-USB-AB (mini)1.5
3 ECG lead wires set, Snap, F-to-M, 25/45/65cm	L3-S-MF-NRP-1-08

Electromagnetic Emissions and Immunity Information

Refer to the following tables for specific information regarding NR device compliance to IEC 60601-1-2.

Models: NR-302, NR-314, NR-314-T, NR-1207, NR-1207-3 and NR-1207-E

Table 1: Electromagnetic Emissions

Emissions Test	Compliance	Electromagnetic Environment—Guidance
<i>This device is intended for use in the electromagnetic environment specified below. The customer and/or user of this device should ensure that it is used in such an environment.</i>		
RF Emissions CISPR 11	Group 2	This device must emit electromagnetic energy in order to perform its intended function. Nearby electronic equipment may be affected.
RF Emissions CISPR 11	Class B	This device is suitable for use in all establishments, including domestic and those directly connected to the public low-voltage power supply network that supplies buildings used for domestic purposes.
Harmonic Emissions IEC 61000-3-2	N/A	
Voltage Fluctuations/Flicker Emissions IEC 61000-3-3	N/A	

Table 2: Electromagnetic Immunity

Immunity Test	IEC 60601 Test Level	Compliance Level	Electromagnetic Environment—Guidance
<i>This device is intended for use in the electromagnetic environment specified below. The customer and/or user of this device should ensure that it is used in such an environment.</i>			
Electrostatic Discharge (ESD) IEC 61000-4-2	±6 kV contact ±8 kV air	±6 kV contact ±8 kV air	Floors should be wood, concrete, or ceramic tile. If floors are covered with synthetic material, relative humidity should be at least 30%.
Electrical Fast Transient/Burst IEC 61000-4-4	±2 kV for power supply lines ±1 kV for input/output lines	N/A	Mains power quality should be that of a typical commercial or hospital environment.
Surge IEC 61000-4-5	±1 kV differential mode ±2 kV common mode	N/A	Mains power quality should be that of a typical commercial or hospital environment.
Voltage dips, short interruptions, and voltage variations on power supply input lines IEC 61000-4-11	±5% UT (>95% dip in UT) for 0.5 cycle ±40% UT (60% dip in UT) for 5 cycles ±70% UT (30% dip in UT) for 25 cycles <5% UT (>95% dip in UT) for 5 sec.	N/A	Mains power quality should be that of a typical commercial or hospital environment.
Power Frequency (50/60 Hz) Magnetic Field IEC 61000-4-8	3 A/m	3 A/m	Power frequency magnetic fields should be at levels characteristic of a typical location in a typical commercial or hospital environment.
NOTE: UT is the AC mains voltage before application of the test level.			

Table 3: Guidance and Manufacturer’s Declaration—Electromagnetic Immunity

Immunity Test	IEC 60601 Test Level	Compliance Level	Electromagnetic Environment—Guidance
<i>This device is intended for use in the electromagnetic environment specified below. The customer and/or user of this device should ensure that it is used in such an environment.</i>			
Portable and mobile RF communications equipment should be used no closer to any part of the device, including cables, than the recommended separation distance calculated from the equation applicable to the frequency of the transmitter.			
Conducted RF IEC 61000-4-6	3 Vrms 150 kHz to 80 MHz	3 Vrms	Recommended Separation Distance $d = 1.17 \sqrt{P}$ $d = 1.17 \sqrt{P}$ 80 MHz to 800 MHz $d = 2.33 \sqrt{P}$ 800 MHz to 2.5 GHz where P is the maximum output power rating of the transmitter in watts (W) according to the transmitter manufacturer and d is the recommended separation distance in meters (m). Field strengths from fixed RF transmitters, as determined by an electromagnetic site survey ^a , should be less than the compliance level in each frequency range ^b . Interference may occur in the vicinity of equipment marked with the following symbol: 
Radiated RF IEC 61000-4-3	3 V/m 80 MHz to 2.5 GHz	3 V/m	

- a. Field strengths from fixed transmitters, such as base stations for radio (cellular/cordless) telephones and land mobile radios, amateur radio, AM and FM radio broadcast and TV broadcast cannot be predicted theoretically with accuracy. To assess the electromagnetic environment due to fixed RF transmitters, an electromagnetic site survey should be considered. If the measured field strength in the location in which the device is used exceeds the applicable RF compliance level above, the device should be observed to verify normal operation. If abnormal performance is observed, additional measures may be necessary, such as reorienting or relocating the device.
- b. Over the frequency range 150 kHz to 80 MHz, field strengths should be less than [3] V/m.

NOTES:

- At 80 MHz and 800 MHz, the higher frequency range applies.
- These guidelines may not apply in all situations. Electromagnetic propagation is affected by absorption and reflection from structures, objects, and people.

Table 4: Recommended Separation Distances

The following table details the recommended separation distances between portable and mobile RF communications equipment and NR device.

<i>This device is intended for use in an electromagnetic environment in which radiated RF disturbances are controlled. Users of this device can help prevent electromagnetic interference by maintaining a minimum distance between portable and mobile RF communication equipment (transmitters) and the device as recommended below, according to maximum output power of the communications equipment.</i>			
Rated Maximum Output Power of Transmitter W	Separation Distance According to Frequency of Transmitter(m)		
	150 kHz to 80 MHz $d = 1.17 \sqrt{P}$	80 MHz to 800 MHz $d = 1.17 \sqrt{P}$	800 MHz to 2.5 GHz $d = 2.33 \sqrt{P}$
0.01	0.12	0.12	0.23
0.1	0.37	0.37	0.74
1	1.2	1.2	2.3
10	3.7	3.7	7.4
100	12	12	23

For transmitters rated at a maximum output power not listed above, the recommended separation distance *d* in meters (m) can be estimated using the equation applicable to the frequency of the transmitter, where *P* is the maximum output power rating of the transmitter in watts (W) according to the transmitter manufacturer.

NOTES:

- At 80 MHz and 800 MHz, the higher frequency range applies.
- These guidelines may not apply in all situations. Electromagnetic propagation is affected by absorption and reflection from structures, objects, and people.

Model NR-314P

Table 5: Electromagnetic Emissions

Emissions test	Compliance	Electromagnetic environment – guidance
RF emissions CISPR 11	Group1 Class B	The NR-314P uses RF energy only for its internal function. Therefore, its RF emissions are very low and are not likely to cause any interference in nearby electronic equipment.
Harmonic emissions IEC 61000-3-2	Class A	The NR-314P is suitable for use in all establishments other than domestic, and may be used in domestic establishments and those directly connected to the public low-voltage power supply network that supplies buildings used for domestic purposes, provided the following warning is heeded: Warning: This equipment is intended for use by healthcare professionals only. This equipment may cause radio interference or may disrupt the operation of nearby equipment. It may be necessary to take mitigation measures, such as re-orienting or relocating the ME EQUIPMENT or shielding the location.
Voltage Fluctuations and Flicker IEC 61000-3-3:2013	Complies	

Table 6: Electromagnetic Immunity

IMMUNITY test	IEC 60601 test level	Compliance level	Electromagnetic environment – guidance
Electrostatic discharge (ESD) IEC 61000-4-2	8 kV contact 2, 4, 8, 15kV air	8 kV contact 2, 4, 8, 15kV air	Floors should be wood, concrete or ceramic tile. If floors are covered with synthetic material, the relative humidity should be at least 30 %.
Electrical fast transient/burst IEC 61000-4-4	2 kV for power supply lines 1 kV for input/output lines	2 kV for power supply lines	Mains power quality should be that of a typical commercial or hospital environment.
Surge IEC 61000-4-5	1 kV line(s) to line(s) 2 kV line(s) to earth 2 kV Signal input/output) to earth	1 kV line(s) to line(s) 2 kV line(s) to earth 2 kV Signal input/output) to earth	Mains power quality should be that of a typical commercial or hospital environment.
Voltage dips, short interruptions and voltage variations on power supply input lines IEC 61000-4-11	0% UT; 0.5cycle at 0°, 45°, 90°, 135°,180°, 225°, 270° and 315° 0% UT; 1cycle and 70% UT; 25/30 cycles Single phase at 0° 0% UT; 250/300 cycle	0% UT; 0.5cycle at 0°, 45°, 90°, 135°,180°, 225°, 270° and 315° 0% UT; 1cycle and 70% UT; 25/30 cycles Single phase at 0° 0% UT; 250/300 cycle	Mains power quality should be that of a typical commercial or hospital environment. If the user of the ME EQUIPMENT requires continued operation during power mains interruptions, it is recommended that the ME EQUIPMENT be powered from an uninterruptible power supply or a battery.
Power frequency (50/60 Hz) magnetic field IEC 61000-4-8	30 (A/m)	30 (A/m)	Power frequency magnetic fields should be at levels characteristic of a typical location in a typical commercial or hospital environment.

Table 7: Guidance and Manufacturer’s Declaration—Electromagnetic Immunity

IMMUNITY test	IEC 60601 TEST LEVEL	Compliance level	Electromagnetic environment – guidance
Conducted RF IEC 61000-4-6	6 Vrms 0,15 MHz – 80 MHz 6 Vrms in ISM bands between 0,15 MHz and 80 MHz 80 % AM at 1 kHz	6 Vrms 0,15 MHz – 80 MHz 6 Vrms in ISM bands between 0,15 MHz and 80 MHz 80 % AM at 1 kHz	Portable and mobile RF communications equipment should be used no closer to any part of the [ME EQUIPMENT including cables, than the recommended separation distance calculated from the equation applicable to the frequency of the transmitter. Recommended separation distance: $d = \left[\frac{3,5}{V_1} \right] \sqrt{P}$ $d = \left[\frac{12}{V_2} \right] \sqrt{P}$ $d = \left[\frac{12}{E_1} \right] \sqrt{P} \quad 80 \text{ MHz to } 800 \text{ MHz}$ $d = \left[\frac{23}{E_1} \right] \sqrt{P} \quad 800 \text{ MHz to } 2,5 \text{ GHz}$
Radiated RF IEC 61000-4-3	10V/m, 80MHz to 2.7GHz, 80% AM at 1kHz	10V/m, 80MHz to 2.7GHz, 80% AM at 1kHz	where P is the maximum output power rating of the transmitter in watts (W) according to the transmitter manufacturer and d is the recommended separation distance in meters (m). Field strengths from fixed RF transmitters, as determined by an electromagnetic site survey, should be less than the compliance level in each frequency range. D Interference may occur in the vicinity of equipment marked with the following symbol: 
Proximity magnetic fields IEC 61000-4-39	8 A/m (30 kHz, CW) 65 A/m (134.2 kHz, pulse modulation 2.1 kHz) 7.5 A/m (13.56 MHz, pulse modulation 50 kHz)	8 A/m (30 kHz, CW) 65 A/m (134.2 kHz, pulse modulation 2.1 kHz) 7.5 A/m (13.56 MHz, pulse modulation 50 kHz)	ME EQUIPMENT containing magnetically sensitive components or circuitry where a separation distance of those components or circuitry of at least 0,15 m from the field sources specified in table below is ensured by the ENCLOSURE or by the physical design of an attached ACCESSORY during INTENDED USE need not be evaluated further for IMMUNITY to proximity magnetic fields in the frequency range 9 kHz to 13,56 MHz.

Table 8: Recommended Separation Distances

The following table details the recommended separation distances between portable and mobile RF communications equipment and NR-314P NR device.

Recommended separation distances between portable and mobile RF communications equipment and the [ME EQUIPMENT or ME SYSTEM]				
Rated maximum output power of transmitter (W)	Separation distance according to frequency of transmitter (m)			
	150 kHz to 80 MHz outside ISM bands	150 kHz to 80 MHz in ISM bands	80 MHz to 800 MHz	800 MHz to 2,5 GHz
	$d = \left[\frac{3,5}{V_1} \right] \sqrt{P}$	$d = \left[\frac{12}{V_2} \right] \sqrt{P}$	$d = \left[\frac{12}{E_1} \right] \sqrt{P}$	$d = \left[\frac{23}{E_1} \right] \sqrt{P}$
0.01	0.12	0.2	0.4	1
0.1	0.37	0.64	1.3	2.6
1	1.17	2	4	8
10	3.7	6.4	13	26
100	11.7	20	40	80

Test specifications for ENCLOSURE PORT IMMUNITY to RF wireless communications equipment				
Test frequency (MHz)	Band (MHz)	Service	Modulation	Immunity Test level (V/m)
385	380 to 390	TETRA 400	Pulse modulation 18 Hz	27

450	430 to 470	GMRS 460, FRS 460	FM ± 5 kHz deviation 1 kHz sine	28
710	704 to 787	LTE Band 13, 17	Pulse modulation 217 Hz	9
745				
780				
810	800 to 960	GSM 800/900, TETRA 800, iDEN 820, CDMA 850, LTE Band 5	Pulse modulation 18 Hz	28
870				
930				
1720	1 700 to 1 990	GSM 1800; CDMA 1900; GSM 1900. DECT; LTE Band 1, 3, 4, 25; UMTS	Pulse modulation 217 Hz	28
1845				
1970				
2450	2 400 to 2 570	Bluetooth, WLAN, 802.11 b/g/n, RFID 2450, LTE Band 7	Pulse modulation 217 Hz	28
5240	5 100 to 5 800	WLAN 802.11 a/n	Pulse modulation 217 Hz	9
5500				
5785				

Test specifications for ENCLOSURE PORT IMMUNITY to proximity magnetic fields		
Test frequency	Modulation	Immunity Test Level (A/m)
30 kHz	CW	8
134.2 kHz	Pulse modulation 2.1 kHz	65
13.56 MHz	Pulse modulation 50 kHz	7.5

FCC Information

 <p>WARNING</p>	<p>For patients with a pacemaker, maintain a minimum of 6 inches (15 cm) between the NR device and pacemaker. Turn the NR device off immediately and provide appropriate patient care if you suspect the NR device affected the pacemaker. The Health Industry Manufacturers Association recommends a minimum 6-inch (15 cm) distance between a wireless radio and a pacemaker, which is consistent with the recommendations of Wireless Technology Research.</p>
---	---

Models NR-302, NR-314, NR-314-T, NR-1207, NR-1207-3 and NR-1207-E contains FCC ID: QOQBT121. Model NR-314P contains FCC ID: QOQ13.

This device complies with Part 15 of the FCC Rules. Operation is subject to the following conditions:

- This device may not cause harmful interference.
- This device must accept any interference received, including interference that may cause undesired operation.

This equipment has been tested and found to comply with the limits pursuant to Part 15 of the FCC Rules. These limits are designed to provide reasonable protection against harmful interference in a residential installation. This equipment generates, uses and radiates radio frequency energy and, if not installed and

used in accordance with the instructions, may cause harmful interference to radio communication. However, there is no guarantee that interference will not occur in a particular installation. If this equipment does cause harmful interference to radio or television reception, which can be determined by turning the equipment off and on, the user is encouraged to try to correct the interference by one or more of the following measures:

- Reorient or relocate the receiving antenna.
- Increase the separation between the equipment and receiver.
- Connect the equipment into an outlet on a circuit different from that to which the receiver is connected.
- Consult the dealer or an experienced radio/TV technician for help.